

MODEL	VOLTAJ (V)	GÜÇ (kW)	DEBİ (m³/h)	SES SEVİYESİ (dB(A))
AXIP 400-5-25	380	0,37	3.000	66
AXIP 450-5-25	380	0,55	4.400	69
AXIP 500-5-25	380	0,55	6.000	72
AXIP 560-5-25	380	0,75	8.200	75
AXIP 630-5-30	380	1,10	14.000	80
AXIP 710-5-30	380	1,50	20.000	83
AXIP 800-5-30	380	2,20	26.000	85
AXIP 800-5-35	380	3,00	32.000	89
AXIP 900-5-35	380	4,00	40.000	90
AXIP 900-5-40	380	5,50	48.000	93
AXIP 1000-5-40	380	7,50	56.000	94

Değerler 0 Pa içindir

OPSİYONLAR

- İstenilen renkte elektrostatik toz boya

MODEL	A (mm)	B (mm)	C (mm)	D (mm)
AXIP 400	570	570	400	200
AXIP 450	610	610	410	200
AXIP 500	650	650	410	200
AXIP 560	680	680	410	200
AXIP 630	750	750	420	200
AXIP 710	830	830	450	200
AXIP 800	920	920	480	200
AXIP 900	1020	1020	590	300
AXIP 1000	1120	1120	700	300

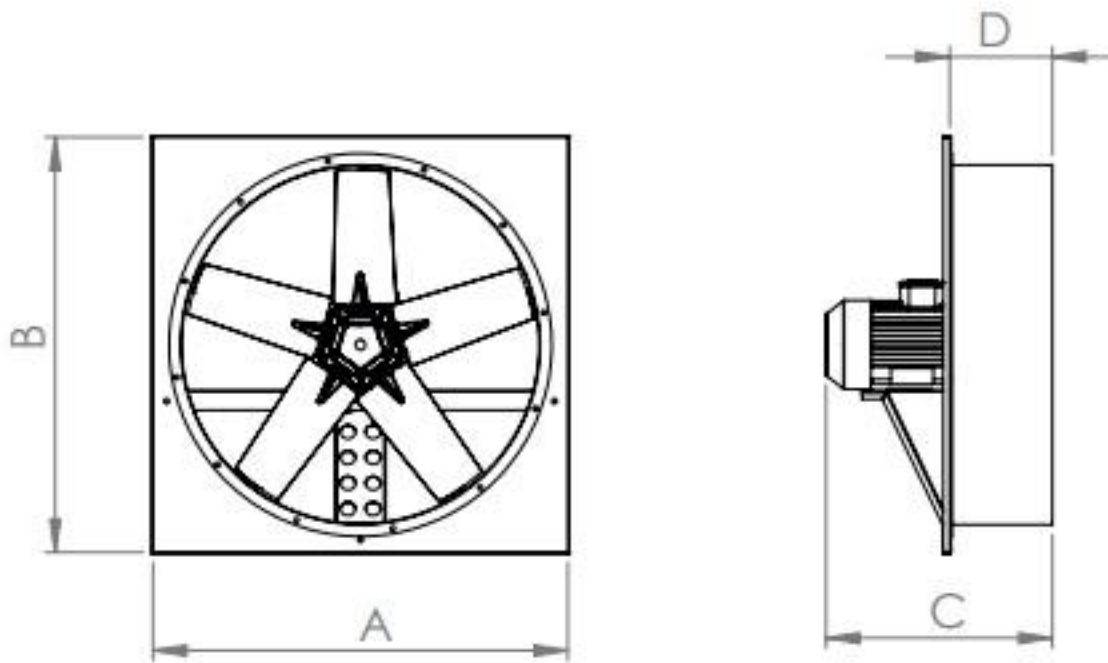

AXIP FAN ÇALIŞMA EĞRİLERİ

AXIP 400-5-25

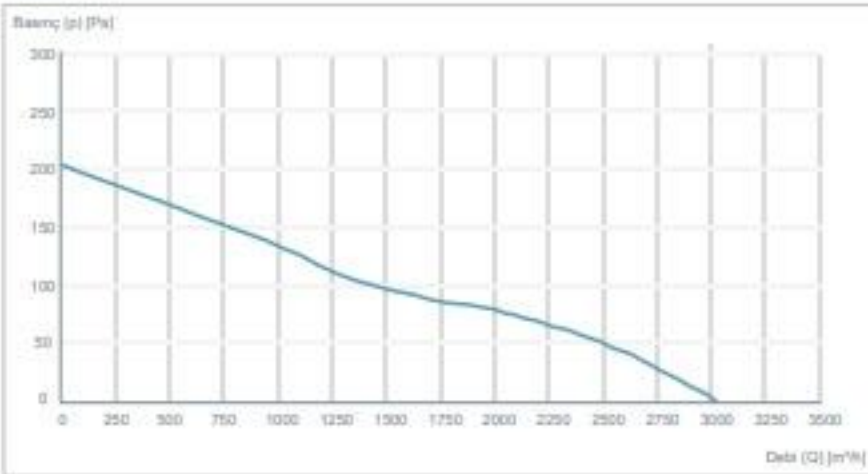

AXIP 450-5-25

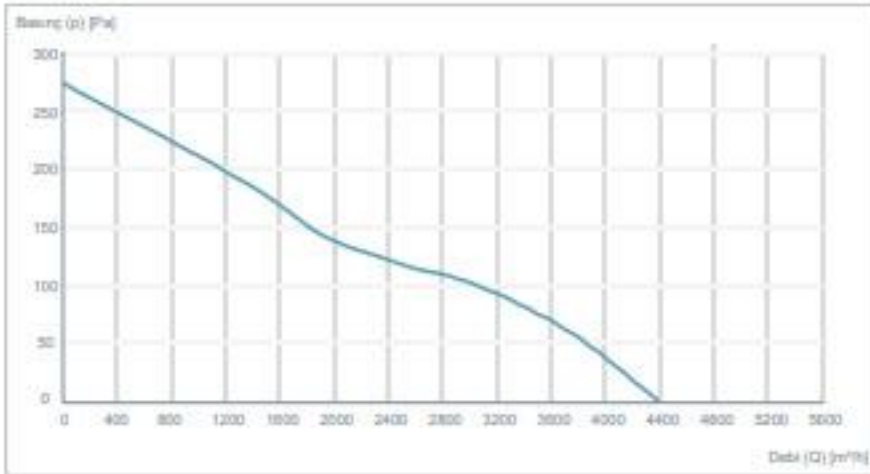

AXIP 500-5-25

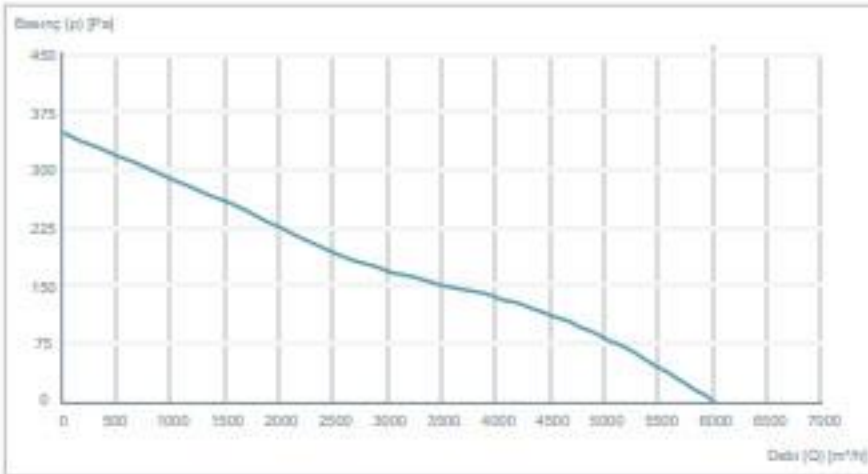

AXIP 560-5-25

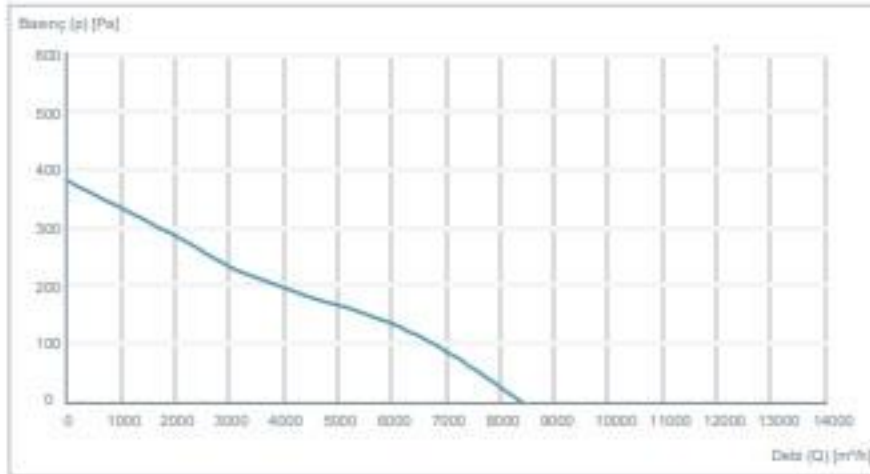

AXIP 630-5-30

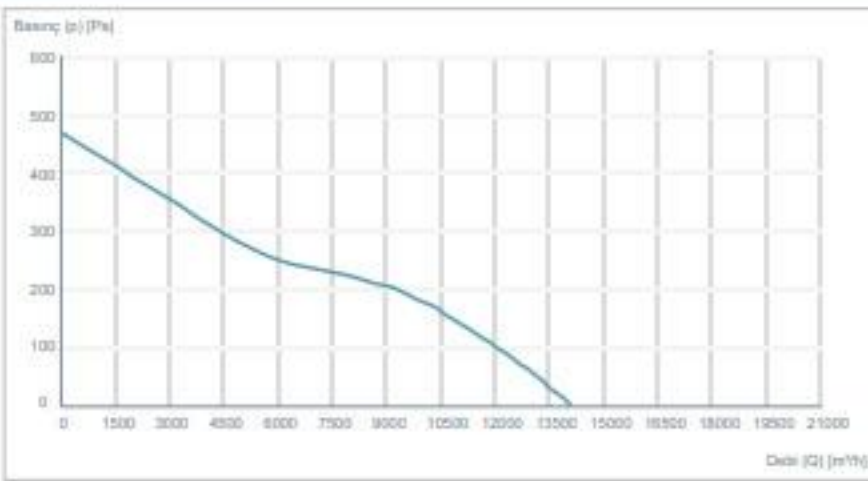

AXIP 710-5-30

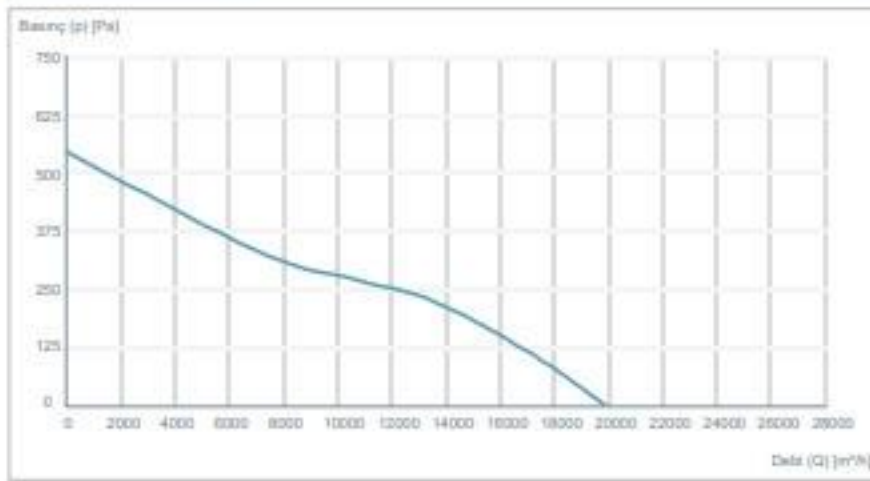

AXIP 800-5-30

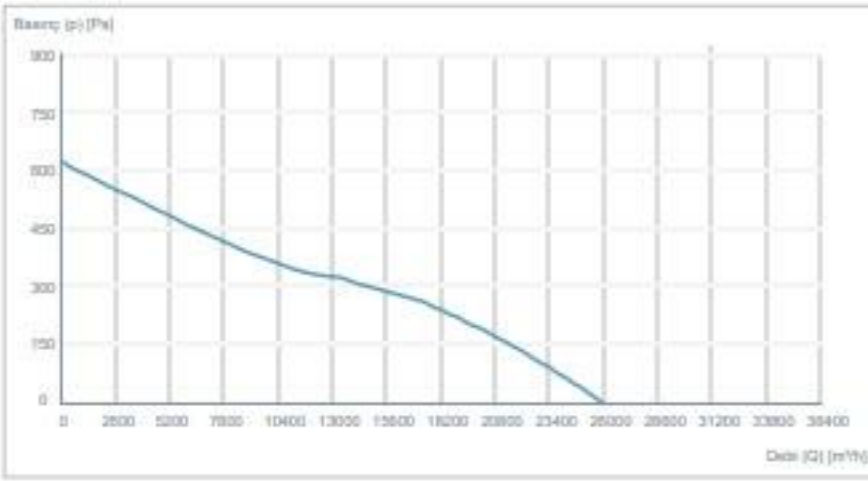

AXIP 800-5-35

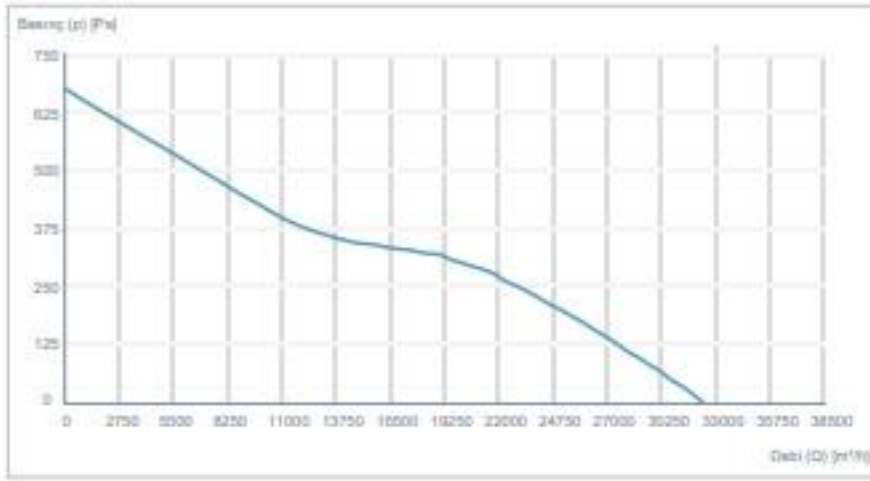

AXIP 900-5-35

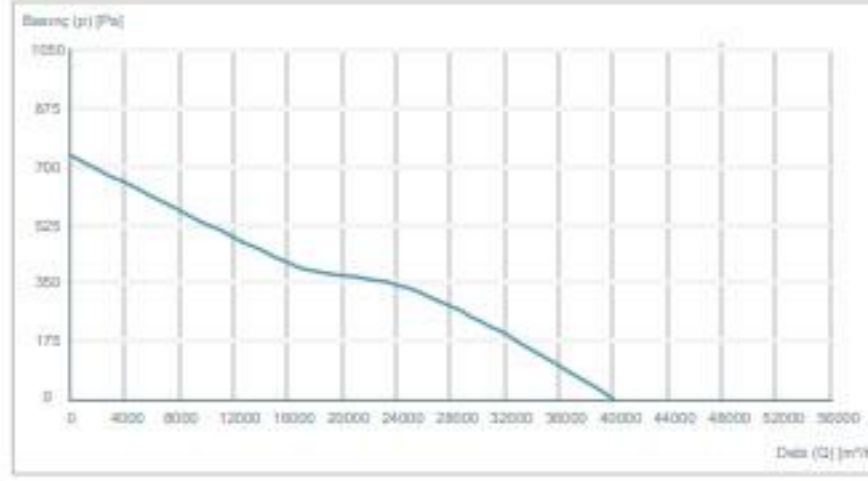

AXIP 900-5-40

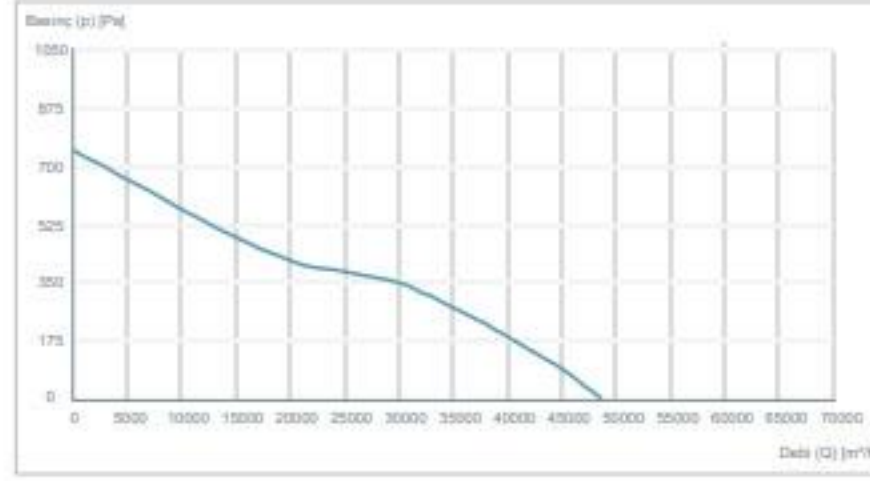

AXIP 1000-5-40

